







FR: Projecteur Kreon 2
 EN: Floodlight Kreon 2
 DE: Flutlicht Kreon 2
 IT: Proiettore Kreon 2
 ES: Proyector Kreon 2
 PL: Iluminacja Kreon 2





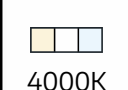

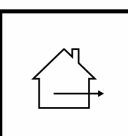

min. 361,0mm²
 max. 361,5mm²

FR : Connexion rapide
 EN : Quick connection
 DE : Schnellverbindung
 IT : Connessione rapida
 ES : Conexión rápida
 PL : Szybkie połączenie

IR
 10m / 180°

	30000h
SMD2835	 110°
 4000K	CRI > 80
 IP44	
230V	
ALU	CE

				CRI	
3297022006449	50W	5000lm	4000K	> 80	20,6x24,7x6,5 cm



PROJECTEUR LED

KREON 2

5000 lumens
50W

IR
10m / 180°

4000K

FR: Floodlight
 EN: Floodlight
 DE: Flutlicht
 IT: Proiettore
 ES: Proyector
 PL: Iluminacja

FR: Connexion rapide
 EN: Quick connection
 DE: Schnellverbindung
 IT: Connessione rapida
 ES: Conexión rápida
 PL: Szybkie połączenie

ARLUX LIGHTING

